

UPPAbaby  
**ROVE**



Rear facing 14 – 50 lbs  
Forward facing 30 – 65 lbs

## Product Information

Registration

Certification

Child Usage Requirements

Start Here

The Right Fit

## Warnings + General Safety Information

## Vehicle Compatibility

Lower Anchors and Tethers for Children (LATCH)

Overview of Vehicle Seat Belt Systems

## Features Overview

Harness Use

Harness Buckle Use

Active Support Headrest Adjustment

Comfort Inlay

Securing the Child

2	Cup Holder Use	30
2	Rear-Facing and Forward-Facing Installation	31
2	LATCH Setup	32
3	LATCH Use and Storage	34
4	Multi Directional Tether Use and Storage	35
5	Recline Adjustment	38

<b>6</b>	<b>Rear-Facing Installation</b>	<b>40</b>
	Setup	42
<b>12</b>	Vehicle Seat Recline	44
14	Lap/Shoulder Belt Use	46
15	Lap Belt Only Use	48
	LATCH Setup	50
<b>18</b>	LATCH Use	52
22	Rear-Facing Tether Use	54
24	Aircraft Use	56
26	Safety Check	57

**Forward-Facing Installation 58**

Setup	60
Lap/Shoulder Belt Use	62
Lap Belt Only Use	64
LATCH Setup	66
LATCH Use	68
Forward-Facing Tether Use	70
Aircraft Use	72
Safety Check	73

**Cleaning and Maintenance 74**

Removing Seat Pad	74
Removing Headrest Fabric	75
Removing Seat Fabric	76
Installing Seat Fabric	78
Installing Headrest Fabric	80
Installing Seat Pad	81
Cleaning	82

**Warranty 83**

Read all instructions before use of this Child Restraint.  
Keep these instructions for future reference.

## Product Information – Registration & Certification

### Registration

Model Number: \_\_\_\_\_

Manufactured Date: \_\_\_\_\_

Expiration Date: \_\_\_\_\_

#### Take a Moment to Fill Out the Above Information.

Information can be found on the manufacture labels or engraved on the underside of the Child Restraint.



Child restraints could be recalled for safety reasons. You must register this restraint to be reached in a recall. Send your name, address, email address if available, and the restraint's model number and manufacturing date to 276 Weymouth Street, Rockland, MA 02370 or call (844) 823-3132 or register online at: [uppababy.com/register/carseat](http://uppababy.com/register/carseat). For recall information, call the U.S. Government's Vehicle Safety Hotline at 1-888-327-4236 (TTY: 1-800- 424-9153), or go to <http://www.NHTSA.gov>

### Certification



This Child Restraint system conforms to all applicable Federal Motor Vehicle Safety Standards (FMVSS).



This Child Restraint is certified for aircraft use. UPPAbaby and the Federal Aviation Administration (FAA) strongly urge you to secure your child in a Child Restraint system (CRS) or device for the duration of your flight.

## Product Information – Child Use Recommendations

### Children should remain rear-facing for as long as possible.

UPPAbaby recommends that children ride rear-facing in the Rove as long as possible, until they reach the maximum weight 50 lbs (22.7 kg) or height allowed in this mode.

**Weight Requirements: 14 – 65 lbs (6.4 – 29.5 kg)**

**Height Requirements: 49 in (124.5 cm) or less**

**REAR FACING 14 – 50 lbs (6.4 – 22.7 kg)**

**FORWARD FACING 30 – 65 lbs (13.6 – 29.5 kg)**

---

The Comfort Inlay is designed for children who weigh **14 – 20 lbs (6.4 – 9 kg)** approximately.

## Product Information – Start Here

### Size Requirements

#### Rear-Facing Installation



From 14 – 50 lbs  
(6.4 – 22.7 kg)  
and 49" (124.5 cm) or less

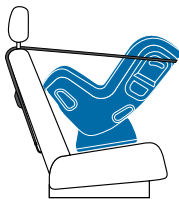

#### Forward-Facing Installation



From 30 – 65 lbs  
(13.6 – 29.5 kg)  
and 49" (124.5 cm) or less



### Recline Position Indicator



Follow **BLUE** recline position indicator **REAR-FACING** seat tilt adjustments. See page 40 for installation instructions.



Follow **RED** recline position indicator **FRONT-FACING** seat tilt adjustments. See page 58 for installation instructions.

### Seat Recline Adjustments

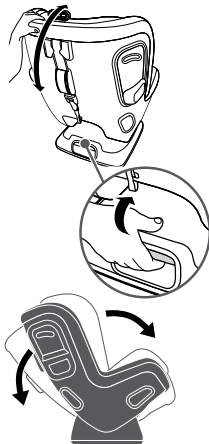

## Product Information – The Right Fit

### Harness Placement

#### Rear-Facing Installation

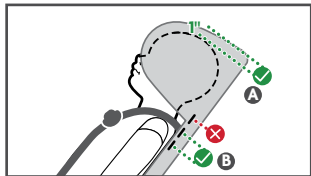

Rear facing: Minimum 1" (2.5 cm) gap between the child's head and top of headrest **A**. Harness should be at the shoulders or 1-2 positions below **B**.

#### Forward-Facing Installation

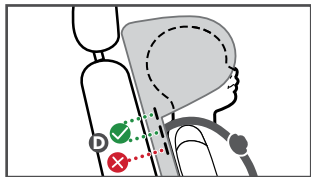

Forward facing: Harness should be at the shoulders or 1-2 positions above **D**.

### Harness Adjustments

#### Add Slack

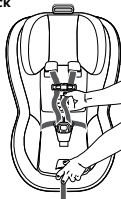

#### Tighten

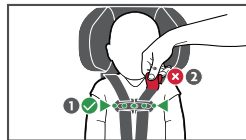
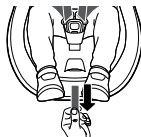

Retainer clip must be at armpit level **1** and harness straps should be snug **2**.

## Warnings + General Safety Information

# **WARNING**

### **DEATH OR SERIOUS INJURY CAN OCCUR**

According to accident statistics, children are statistically safer when properly restrained in the rear seating positions than in the front seating positions, whether there are airbags, advanced airbags or no airbags at all. To ensure your child's safety refer to approved seating positions on page 12 in this manual or your Vehicle's Owner Manual.



**NEVER** place this Child Restraint on a front seat with an airbag. **DEATH OR SERIOUS INJURY** can occur. An airbag can strike a rear-facing infant restraint with enough force to crack the shell and seriously injure or kill an infant. The back seat is the safest place for children 12 and under. Refer to the vehicle owner's instruction book before installing this Child Restraint in a seating position with side airbags.



## Warnings + General Safety Information

Snugly adjust the belts provided with this Child Restraint around your child. A snug strap should not allow any slack. It lies in a relatively straight line without sagging. It does not press on the child's flesh or push the child's body into an unnatural position.

Never leave Child Restraint unsecured in your vehicle even when it is unoccupied. In a crash, it could become a projectile and injure other vehicle occupants.

### **WARNING**

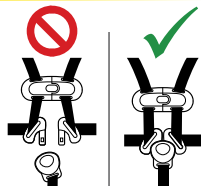

Children have **STRANGLED** in loose or partially buckled harness straps. Fully restrain the child in the seat at all times. **DO NOT** put a child in the seat outside of the vehicle.

## Warnings + General Safety Information

### SAFETY WARNINGS

Failure to follow these instructions could result in serious injury to your child or other vehicle occupants.

- **NEVER** leave child unattended.
- **ALWAYS** keep child properly harnessed when child is in Child Restraint.
- **NEVER** leave child in convertible car seat when straps are loose or undone.
- **DO NOT** use seat if it is damaged or broken, expired (over 10 years from date of manufacture), missing instructions, missing parts, or if the straps are cut, frayed, or damaged in any way.
- **DO NOT** use this Child Restraint system if it has been in a vehicle accident.
- **DO NOT** use clothing or blankets that interfere with fastening or tightening the harness **INSTEAD** place a blanket over the child after being properly secured in the harness.

## Warnings + General Safety Information

- **DO NOT** use this Child Restraint system if the top of the child's head is less than 1 in (2.54 cm) from the top of the headrest when in its highest position.
- **DO NOT** use this Child Restraint system in a vehicle seating position where it cannot be tightly secured.
- **DO NOT** install in rear-facing or side-facing vehicle seats.
- **DO NOT** modify this restraint except as instructed in this instruction book. Minor modifications can change the way a Child Restraint performs in a crash.
- **DO NOT** take child out of the Child Restraint while the vehicle is moving.
- **DO NOT** allow children to play with this Child Restraint. It is not a toy.
- **DO NOT** remove or cover up any of the warning or product labels on this Child Restraint. All labels include information required by law.

## Warnings + General Safety Information

- **DO NOT** use any accessories, pads, or products supplied by other manufacturers with this Child Restraint, unless approved and tested by UPPAbaby. Items not tested with this restraint could injure your child.
- **DO NOT** lubricate buckles and fasteners.
- **DO NOT** use a Child Restraint with damaged or missing parts.
- **ALWAYS** check all surfaces of restraint before securing your child. In warm weather, Child Restraints can become very hot. Park in the shade or where sun does not directly hit the Child Restraint. Cover the Child Restraint with a sheet or blanket when not in use.
- **ALWAYS** properly store lower anchor connectors when not in use.

## Warnings + General Safety Information

- Check the vehicle owner's manual for more information about airbag/Child Restraint use.
- For vehicles without a back seat, refer to your vehicle owner's manual.
- Check the vehicle belt before each use. Use only if the belt is tightened properly and securely.
- Placing your child in a hot Child Restraint may result in burns.
- Read all instructions for additional warnings.



## Vehicle Compatibility

The safest seating position is one that works best for your specific car seat, family and vehicle where you are able to achieve the tightest install every time. Before installing this Child Restraint you **MUST** determine the method of installation and the best vehicle seating position for that method. This Child Restraint can be installed either using the **VEHICLE SEAT BELT** or **LATCH**. When determining the best method of installation, it is critical that you refer to your vehicle owner's manual.

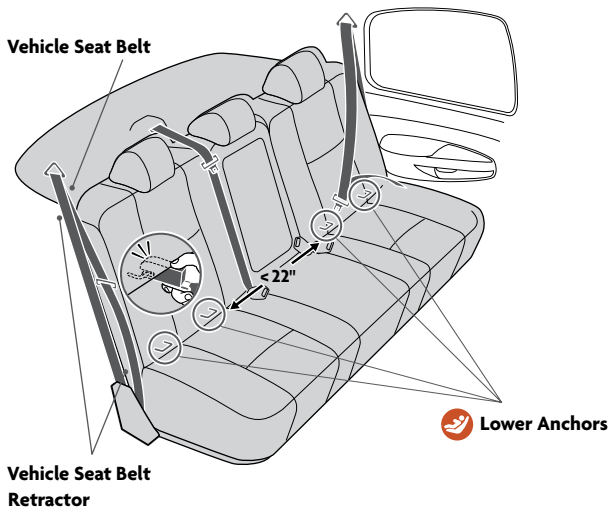

## Vehicle Compatibility

This Child Restraint can only be installed on vehicle seats that face forward.

**DO NOT** install in seats that face to the sides or rear of the vehicle.

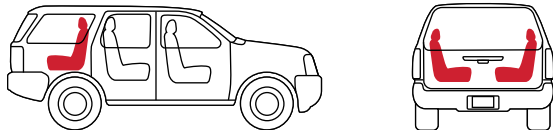

**ALWAYS** park on a level surface when installing a Child Restraint.

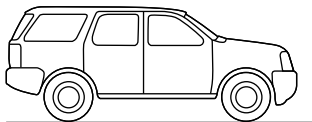

## Vehicle Compatibility – LATCH (Lower Anchors and Tethers for Children)

Most vehicles manufactured after September 1, 2002 are equipped with LATCH (Lower Anchors and Tethers for Children). Check your vehicle owner's instruction book to determine lower anchor compatible seating positions.

NOTE: In order to use the rear center seating position with lower anchor, the distance between the lower anchors may be up to 22 in (55.9 cm) and the seating position must be approved by the vehicle manufacturer. If spacing between the lower anchors is greater than 22 in (55.9 cm) or if the seating position is not approved by the vehicle manufacturer then use the vehicle seat belt for installation.

**WARNING: DO NOT** use the Lower Anchorage System (**LATCH**) to attach this Child Restraint when restraining a child weighing more than **40 lbs (18.1 kg)** for Rear-Facing installation and **45 lbs (20.4 kg)** for Forward-Facing installation.

### Vehicle Top Tether Anchor Points



### Vehicle Lower Anchor Points



## Vehicle Compatibility – Overview of Vehicle Seat Belt Systems

**DO NOT use this Child Restraint with the following seat belt systems:**

**WARNING: DEATH OR SERIOUS INJURY CAN OCCUR.** CHECK

YOUR Vehicle instruction book for information regarding your vehicle seat belt system(s). Not all vehicle seat belts work with this Child Restraint.

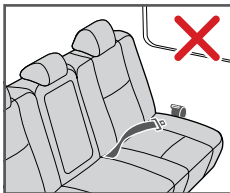

**Lap belts with emergency locking retractor**

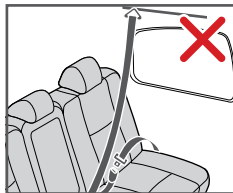

**Motorized (automatic)**

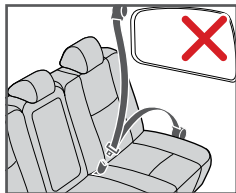

**Lap/Shoulder with two retractors**

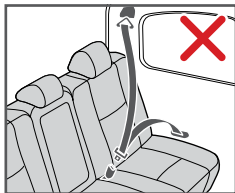

**Door mounted**

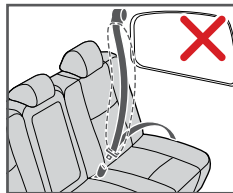

**Inflatable**

## Vehicle Compatibility – Overview of Vehicle Seat Belt Systems

**Check your vehicle owner's instruction manual** for information regarding your vehicle seat belt system(s).

**This Child Restraint is compatible with most vehicle seat belt systems.**

**Belts MUST be able to lock.**

Refer to vehicle owner's manual to determine if the belts in your vehicle lock by switching the seat belt's retractor or they have a locking latch plate that locks the vehicle's seat belts so they will not move freely. If the belt cannot be locked using one of these methods, contact UPPAbaby Customer Experience Team for a locking clip.

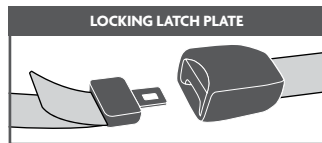
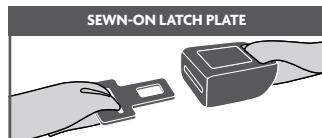
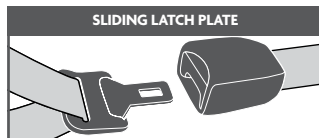
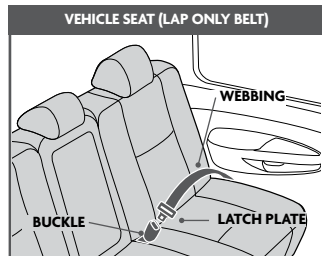
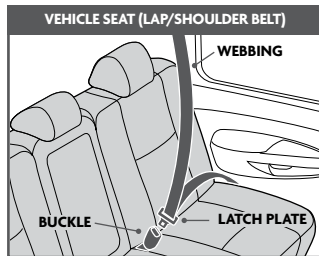



## Features Overview

- 1 Shoulder Harness Pads
- 2 Harness Buckle
- 3 Buckle Pad
- 4 Harness Release Button
- 5 Harness Adjuster Strap
- 6 Lower Anchor Connector LATCH Storage
- 7 Comfort Inlay
- 8 Cup Holder
- 9 Chest Clip



## Features Overview

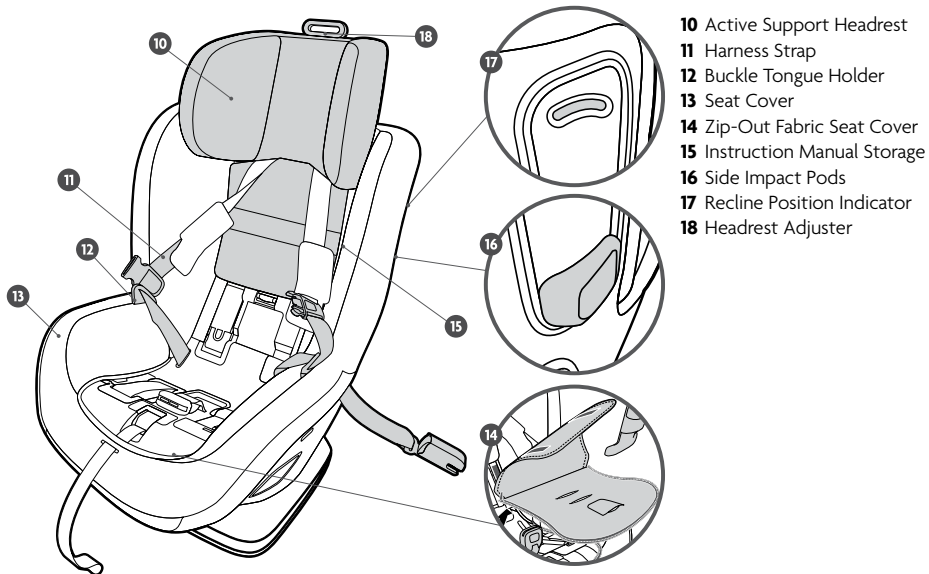

## Features Overview

- 19** Rear-Facing Lock-Off Door
- 20** Rear-Facing Tensioning Indication
- 21** Tightness Indicators with SmartSecure
- 22** Forward-Facing Lock-Off Door
- 23** Forward-Facing Tensioning Indication

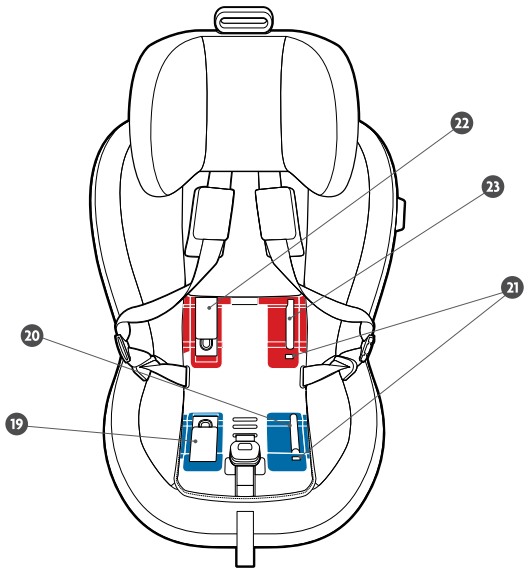

## Features Overview

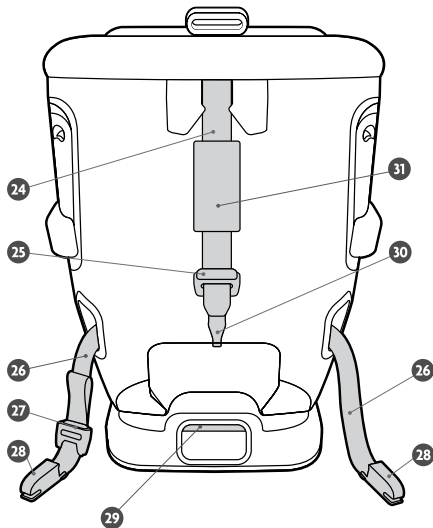

**24** Multi-Directional Tether

**25** Multi-Directional Tether Adjuster

**26** Lower Anchor LATCH Connector Webbing

**27** Lower Anchor LATCH Connector Adjuster

**28** Lower Anchor LATCH Connector

**29** Recline Adjustment Handle

**30** Multi-Directional Tether Hook

**31** Multi-Directional Tether Closure Sleeve

## Features Overview – Harness Use

### Loosen Harness

- 1 Loosen Harness by pressing Harness Release Button on front of Child Restraint **A** and pulling forward on both Harness Straps **B**.
- 2 Unbuckle Harness Straps by pushing on Harness Buckle and pull out buckle tongues.
- 3 Open Chest Clip by pressing button on clip and pulling apart.
- 4 Secure Buckle Tongues in storage pockets.

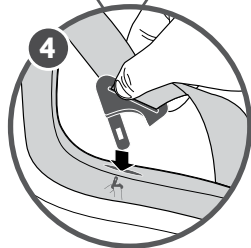
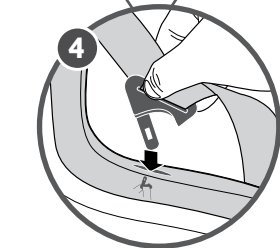
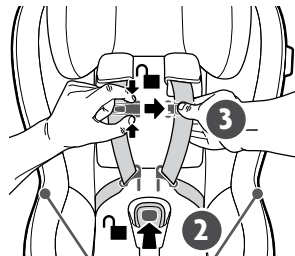
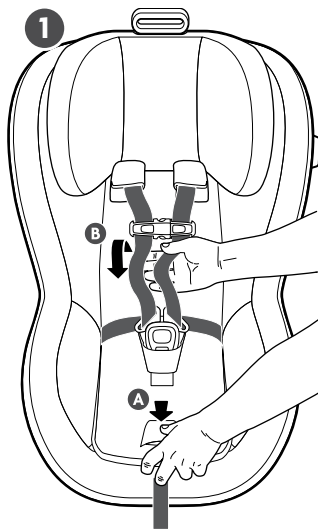



## Features Overview – Harness Use

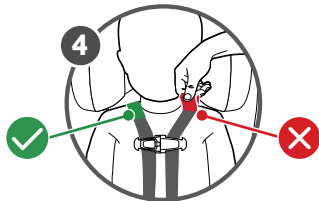
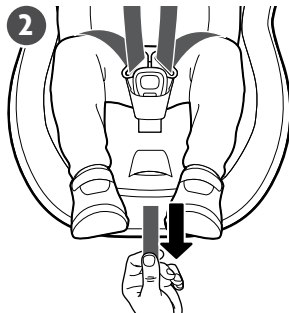
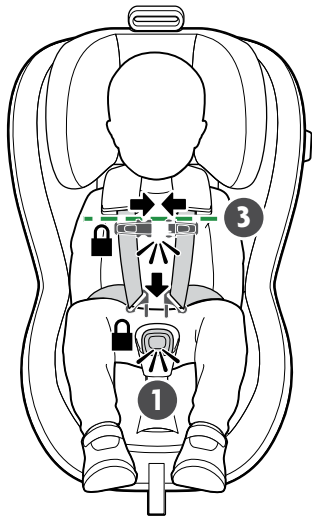

### Tighten Harness

- 1 Place harness over child and insert buckle tongues into the buckle until a “click” is heard. Pull up on the buckle tongues to make sure they are locked.
- 2 Pull up on the harness to remove excess slack around the child’s legs. Pull harness adjuster strap to tighten.
- 3 Close the chest clip and position at armpit level.
- 4 Harness should be snug. Pinch harness webbing at child’s shoulder (under shoulder pad). If you can pinch webbing, the harness is too loose and should be tightened.

**Note:** Harness pads are optional. Reference page 28 (Securing The Child) for additional information.

## Features Overview – Harness Buckle Use

The crotch belt has three use positions. Always position the buckle strap in the slot closest to the child. If the child is on top of the buckle in the inner position, then adjust the buckle to next outer position.

- 1 Remove Comfort Inlay and buckle pad.
- 2 Partially unzip the cushion fabric and lift upward to expose to buckle adjustment.
- 3 Twist the buckle harness webbing to align with vertical slot that slides between buckle positions. Slide to desired location and twist the webbing into the slot completely making sure the red button is facing forward **3B**.
- 4 Replace soft goods ensuring the harness buckle is in the correct location.

**Note:** Buckle should rest up against the child's lower body and never underneath them.

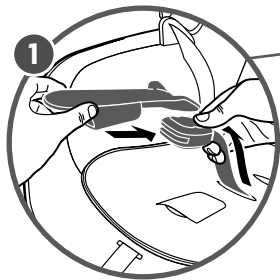

## Features Overview – Harness Buckle Use

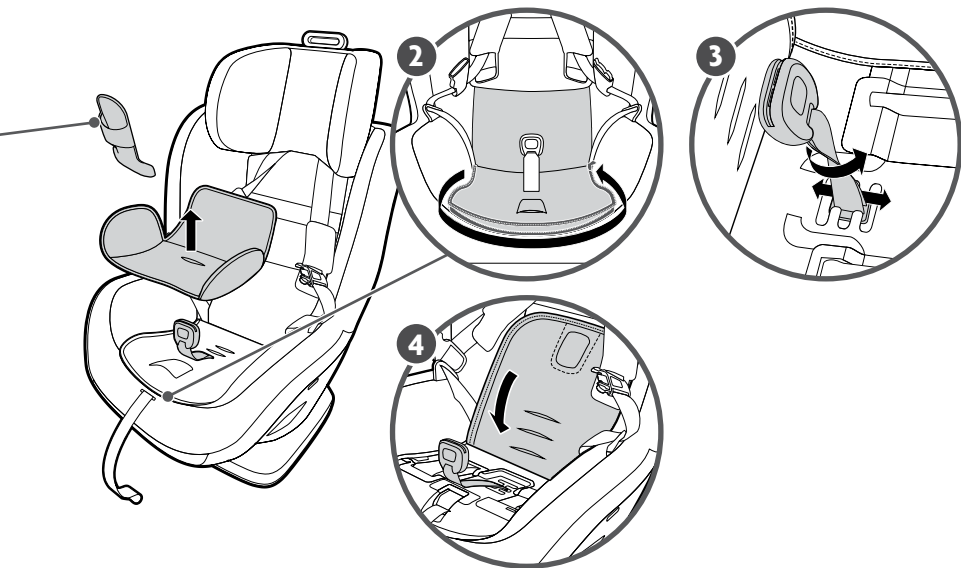

## Features Overview – Active Support Headrest Adjustment

The Active Support Headrest and harness provide advanced Side Impact Protection that grows with the child.

- 1 Loosen Harness (page 22).
- 2 Squeeze the Headrest Adjuster and move the headrest up or down to the desired position by pushing down and pulling up on handle. The harness will travel up or down with the headrest.

### REAR-FACING

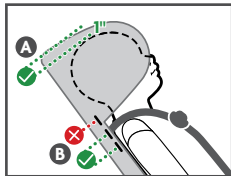

### FORWARD-FACING

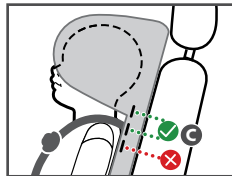

Rear-facing: Minimum 1" (2.5 cm) gap between the child's head and top of headrest **A**. Harness should be at the shoulders or 1-2 positions below **B**. Forward-facing: Harness should be at the shoulders or 1-2 positions above **C**.

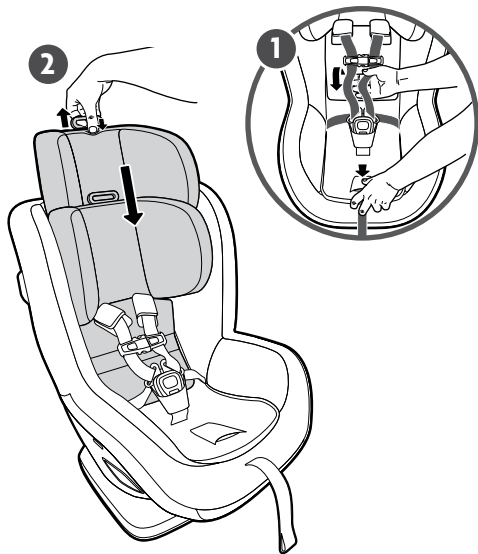

## Features Overview – Comfort Inlay

The Comfort Inlay should be used Rear-Facing for a child between 14 and 20 lbs (6.4 kg–9 kg) approximately.



**1** Place Comfort Inlay in seat and pull harness buckle and cover through slot in bottom of the inlay.

**2** Push Comfort Inlay firmly into Child Restraint.

**Note:** Remove the Comfort Inlay at 20 lbs (9 kg) or when the child begins growing on top of the buckle making it difficult to buckle the harness. The Comfort Inlay has a one-piece construction.

## Features Overview – Securing the Child

- 1 Loosen and unbuckle harness.
- 2 Place child in Child Restraint making sure their body is making full contact with the seating surface.
- 3 Adjust Active Response Headrest by pushing down and pulling up on handle so the harness slots are at or one to two positions below the shoulders for **REAR-FACING** OR at or one to two positions above the shoulders for **FORWARD-FACING**.  
(Steps 3-7 illustrations shown on next page)
- 4 Place harness over child and insert buckle tongues into the buckle until a “click” is heard. Pull up on the buckle tongues to make sure they are locked.
- 5 Pull up on the harness to remove excess slack around the child’s legs. Pull harness adjuster strap to tighten.
- 6 Close the chest clip and position at armpit level.
- 7 Harness should be snug. Pinch harness webbing at child’s shoulder. If you can pinch webbing, the harness is too loose and should be tightened.  
**Note:** Harness pads are optional and can be removed to help get the chest clip to armpit level.

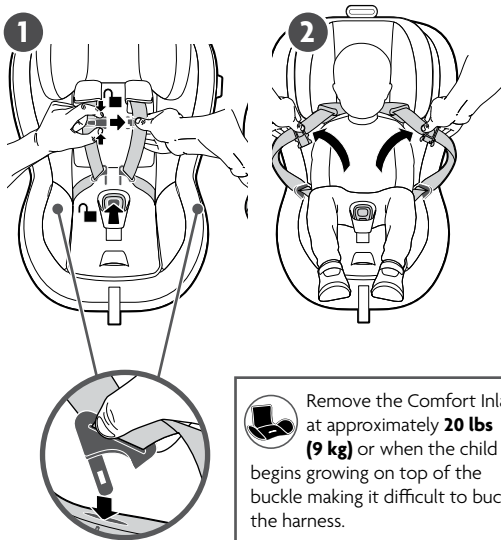

Remove the Comfort Inlay at approximately **20 lbs (9 kg)** or when the child begins growing on top of the buckle making it difficult to buckle the harness.

## Features Overview – Securing the Child

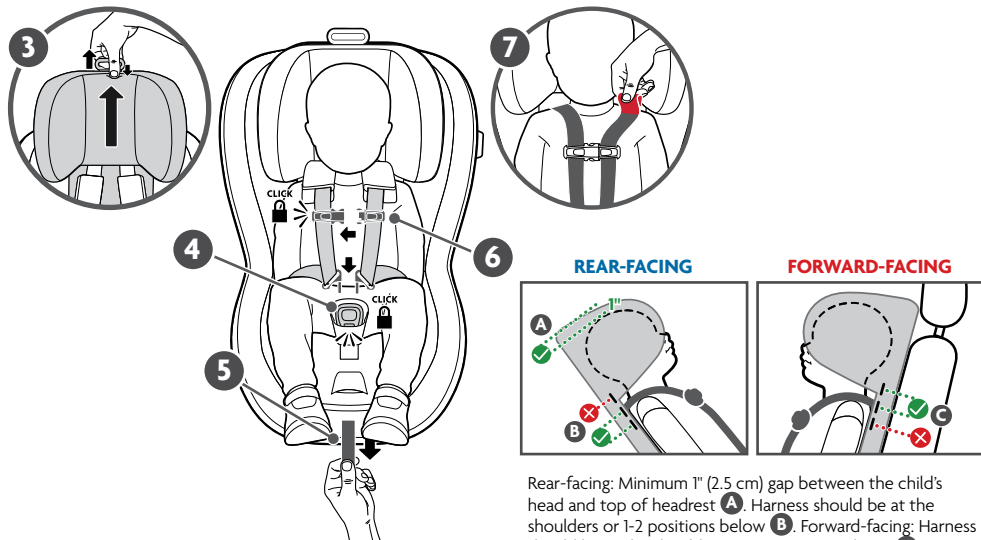

Rear-facing: Minimum 1" (2.5 cm) gap between the child's head and top of headrest **A**. Harness should be at the shoulders or 1-2 positions below **B**. Forward-facing: Harness should be at the shoulders or 1-2 positions above **C**.

## Features Overview – Cup Holder Use

### To Attach the Cup Holder:

Push cup holder stem into designated slot in side of Child Restraint.

### To Remove the Cup Holder:

Tilt cup holder upward and pull firmly.



**WARNING: DO NOT** place glass, metal containers or hard sharp objects in cup holder as they could become a projectile in a crash and cause serious injury. **NEVER** put a hot liquid in the cup holder.



## Features Overview – Rear-Facing and Forward-Facing Installation

This Child Restraint features a **BLUE BELT PATH** with a lock-off door and clear indicators to ensure a secure and proper install for **REAR-FACING INSTALLATION**. It also has a **RED BELT PATH** with a lock-off door and clear indicators to ensure a secure and proper install for **FORWARD-FACING INSTALLATION**.

Both Belt Paths feature a SMARTSecure visual window that turns from **RED** to **GREEN** when correct installation has been achieved.

**Note:** The SMARTSecure **RED** to **GREEN** indicator is a guide for confirming a tight installation. As all vehicle makes and models are different, it is possible that a tight installation has been achieved even though the window is not fully green. Always assess the install by checking at the belt path that the seat does not move more than 1" (2.5 cm) side to side or front to back on the vehicle seat.

### To Access Either Belt Path

- 1 Loosen harness (page 22).
- 2 Raise the Active Support Headrest to highest position by pushing down and pulling up on handle (page 26).
- 3 Unfasten fabric seat pad as needed for better access.

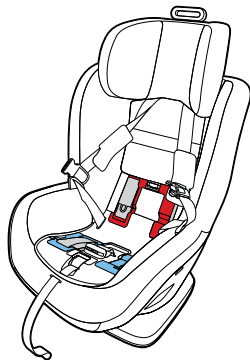
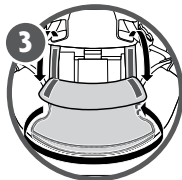
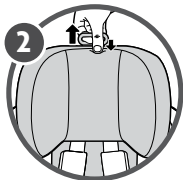
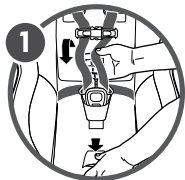

## Features Overview – LATCH Setup

### To Access Lower Anchor Connectors

- 1 To access Lower Anchor Connectors unsnap fabric over front panel of Child Restraint. Open the storage compartment and pull out the Lower Anchor webbing and release the Connector by pressing the red button on the connector and pull to detach.
- 2 Lengthen the Lower Anchor Connector to maximize length by pushing the Lower Anchor Connector Adjuster Button and pulling to full extension.
- 3 Loosen harness. (page 22)
- 4 Raise headrest to maximum height by pushing down and pulling up on handle.
- 5 Unfasten the fabric and expose the **REAR-FACING** or **FORWARD-FACING** belt path.
- 6 Route Lower Anchor Connectors and Belt under fabric seat pad from front of seat aligning webbing with **FORWARD-FACING** or **REAR-FACING** belt path. (See page 50 and 66)

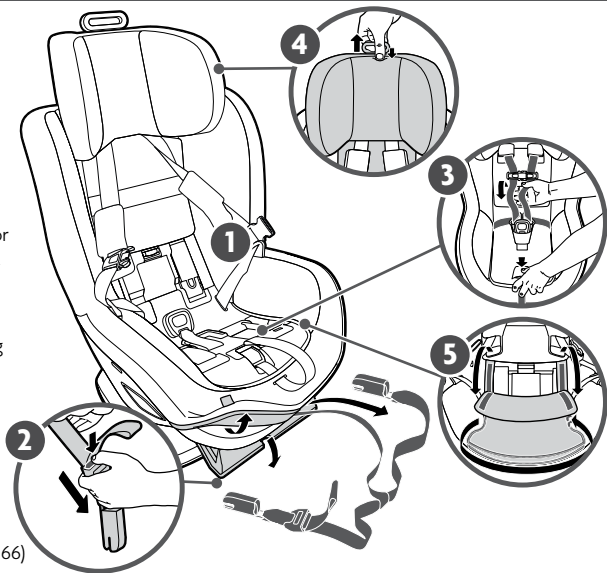

## Features Overview – LATCH Setup

**Note:** Slide Belt tether loop to side to not interfere with LATCH installation.



**REAR-FACING Latch Installation** (page 50)  
**14–50 lbs (6.4–22.7 kg)**

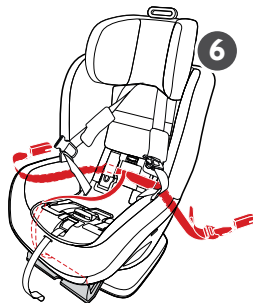

**FORWARD-FACING Latch Installation** (page 66)  
Not preferred method for forward-facing installation  
**30–65 lbs (13.6–29.5 kg)**

**WARNING: DO NOT** use the Lower Anchorage System (LATCH) to attach this Child Restraint when restraining a child weighing more than **40 lbs (18.1 kg)** for Rear-Facing installation and **45 lbs (20.4 kg)** for Forward-Facing installation.

## Features Overview – LATCH Use and Storage

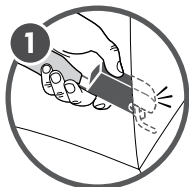

**1 Lock** To connect Lower Anchor Connectors to Lower Anchors in vehicle, push connector onto lower anchor until you hear a click. Pull to confirm attachment.

**Note: DO NOT** push the red button.

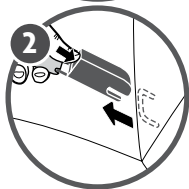

**2 Release** To release Lower Anchor Connectors, press red button at end of connector and pull to detach.



**3 Store** To store, fold Lower Anchor Connector and place into storage compartment, tucking away excess webbing. Close door until firmly in place. Snap fabric onto panel.

When not in use, the Lower Anchor Connectors **MUST** be properly secured in the dedicated storage compartment under the front leg rest portion of the Child Restraint.

**WARNING: DO NOT** use LATCH to attach this Child Restraint when restraining a child weighing more than **40 lbs (18.1 kg)** for Rear-Facing installation and **45 lbs (20.4 kg)** for Forward-Facing installation. Please refer to your vehicle owner's manual for LATCH information.

## Features Overview – Multi Directional Tether Use and Storage

**ATTENTION: IT IS STRONGLY RECOMMENDED** to utilize the Multi-Directional Tether for **FORWARD-FACING** and **REAR-FACING** installation if vehicle is equipped with a Tether Anchor point and vehicle requirements are met. The tether will improve the stability of your Child Restraint and help to reduce the potential for injury. See your vehicle owner's manual for approved anchor locations and routing instructions.

**REAR-FACING**  
**Multi-Directional Tether Installation** (page 54)

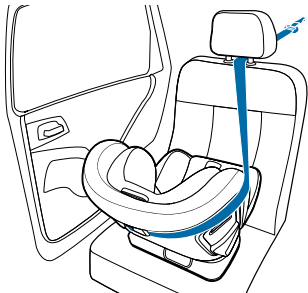

Route the webbing either through the vehicle headrest posts or if an integrated headrest exists, to the same side you routed the tether.

**FORWARD-FACING**  
**Multi-Directional Tether Installation** (page 70)

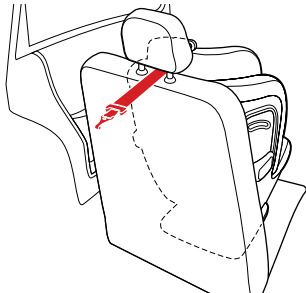

Route the webbing either through the vehicle headrest posts or if an integrated headrest exists, over the top of the headrest.

## Features Overview – Multi Directional Tether Use and Storage

### Using the Multi-directional Tether

- 1 Unhook the Multi-Directional Tether located on the back side of the Child Restraint.
- 2 To lengthen the strap, push the Multi-Directional Tether Adjuster button and pull downward

**Note:** Maximize length of tether before Rear and Forward-Facing installations.

- 3 The Multi-Directional Tether webbing is intentionally long. Once attached, roll the excess webbing around the fabric sleeve and secure.

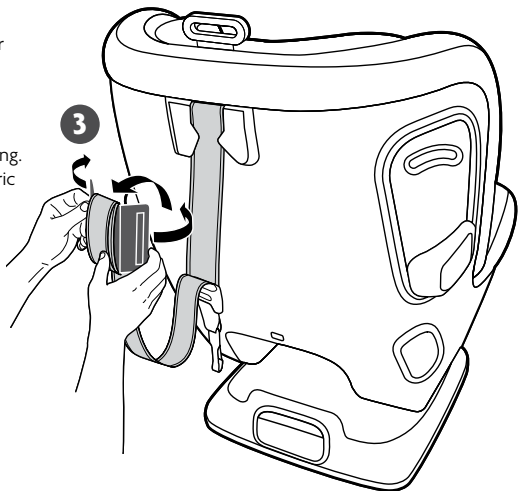
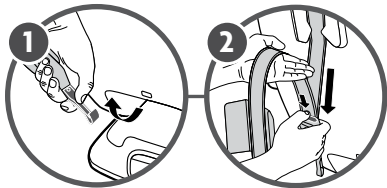

## Features Overview – Multi Directional Tether Use and Storage

### Storing the Multi-directional Tether When Not in Use

- 1 Attach Multi-Directional Tether to storage anchor.
- 2 Remove slack in strap by pulling on free end of strap.

**Note:** Make sure the webbing is not twisted.

- 3 Loose strap **MUST** be rolled around the fabric closure and secured.

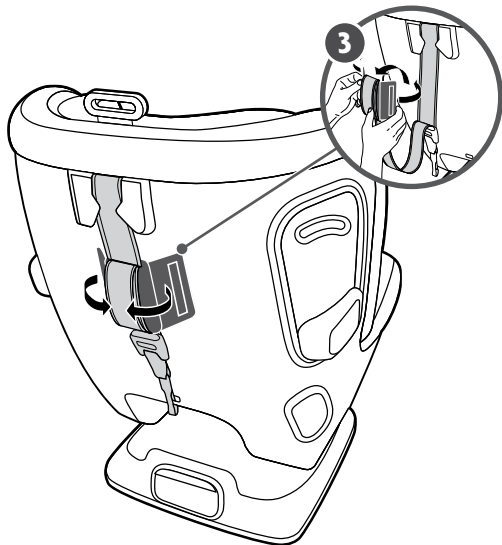

When not in use, the Multi-Directional Tether **MUST** be stored properly.

## Features Overview – Recline Adjustment

This Child Restraint has 5 recline positions. Recline can be changed to improve installation of this Child Restraint and for child comfort. When first using the seat in **REAR-FACING** mode, ensure proper child positioning by reclining the child restraint to the maximum recline position.

**To Adjust the Recline:** Pull the Recline Adjustment Handle located on the back of Child Restraint upward and move the seat to the desired recline position **A**.

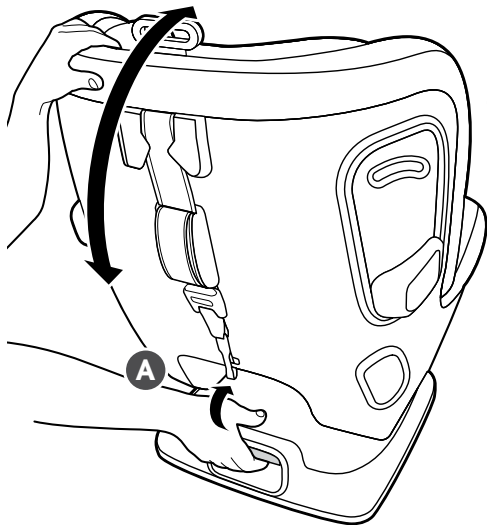



## Features Overview – Recline Adjustment

### REAR-FACING Installation

14–50 lbs (6.4–22.7 kg)



**ALWAYS** check the Recline Position Indicator and adjust the recline so that the bubble is between the correct **BLUE** area for **REAR-FACING** Installation.

### FORWARD-FACING Installation

30–65 lbs (13.6–29.5 kg)



**ALWAYS** check the Recline Position Indicator and adjust the recline so that the bubble is between the correct **RED** area for **FRONT-FACING** Installation.



## Rear-Facing Installation

14–50 lbs (6.4–22.7 kg)

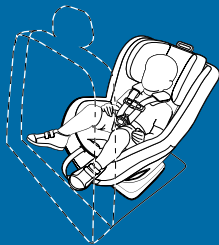



**Vehicle belt: 14–50 lbs** (page 46)



**LATCH: 14–40 lbs** (page 50)



**Comfort Inlay: 14–20 lbs** (page 27)

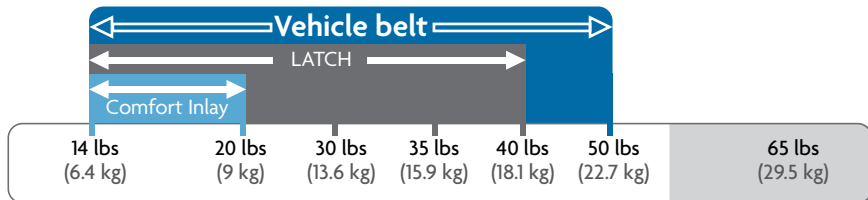

## Rear-Facing Installation – Setup

This Child Restraint has **3 recline positions**. Recline can be changed to improve installation of this Child Restraint and for child comfort. The Comfort Inlay should be used with children 14-20 lbs (6.4–9 kg) approximately.

When first using the seat in **REAR-FACING** mode, ensure proper child positioning by reclining the child restraint to the maximum recline position.

**Note:** Ensure you are parked on level ground before adjusting recline

- 1 Place Child Restraint on vehicle seat in the **REAR-FACING** direction as shown. Ensure the bottom surface is flush against the vehicle seat without any gapping or tilting.
- 2 To adjust recline, pull the Recline Adjustment Handle and move the seat to the desired recline position.

**Note:** 80% of the base should be in contact with the vehicle cushion.

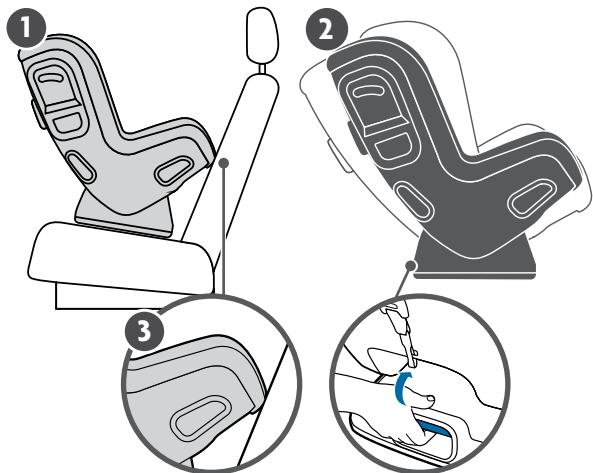

## Rear-Facing Installation – Setup

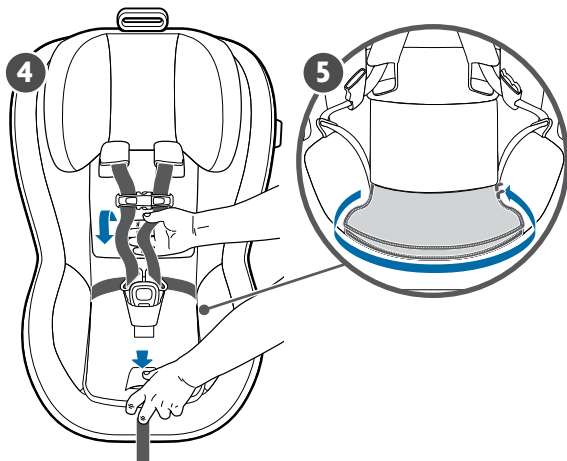

- 3 Slide Child Restraint towards the back of the vehicle seat until it makes contact with the vehicle seat back.
- 4 Unbuckle and loosen harness
- 5 Remove buckle pad and unzip fabric panel to expose the **BLUE REAR-FACING** Belt Path. (page 29)

To complete **REAR-FACING** installation, please refer to:

**Lap/Shoulder Belt** page 46

**Lap Belt Only** page 48

**Latch** page 50

## Rear-Facing Installation – Vehicle Seat Recline

Some cars may have a different type of seat that is more angled or sloped. In this instance, it may be more difficult to achieve the proper recline angle.

If recline position cannot be achieved, this is an easy issue to resolve by following the steps below:

**Note:** Ensure you are parked on level ground before adjusting recline.

### 1 Set up your Rove

**Note:** Place a folded hand towel under the Rove against the seat bight (crease of seat). You may need to adjust number of folds to achieve the proper recline.

2 Once the bead is in the correct **BLUE** area for **REAR-FACING INSTALLATION**, proceed with installation. Follow Safety Check (page 57) to confirm proper steps.

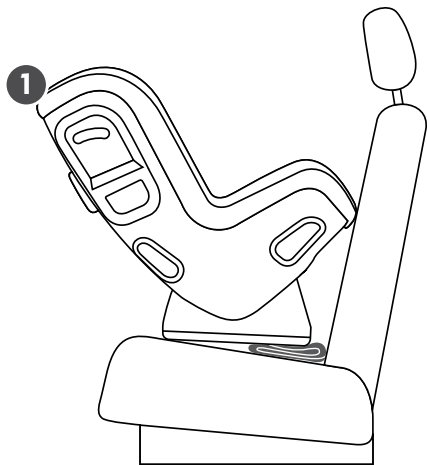

## Rear-Facing Installation – Vehicle Seat Recline

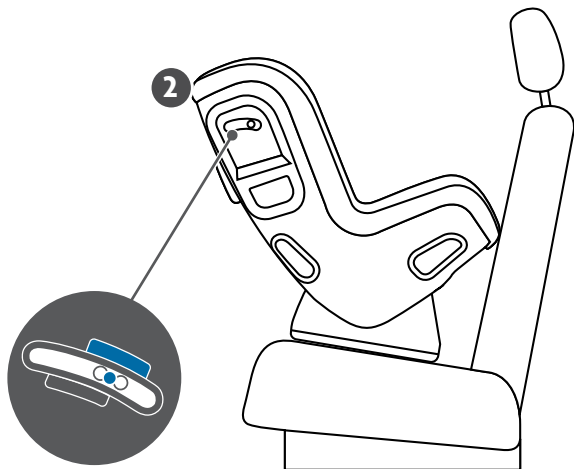

This Child Restraint has **3 recline positions**. in REAR-FACING mode. For infants aged 0-4 months, use the most reclined position for optimal comfort and support.



## Rear-Facing Installation – Lap/Shoulder Belt Use

- 1 Open the lock-off door.
- 2 Ensuring there is no twisting in the vehicle belt, route seat belt through the lock-off and through the **BLUE-REAR-FACING** belt path. Buckle.
- 3 While applying pressure into seating surface, as shown, pull up on the vehicle shoulder belt to tighten the belt. Holding the shoulder belt taut to ensure no slack is introduced back into the vehicle belt, route through the lock-off (Steps 3-4 are on next page)
- 4 Close the top section of the lock-off door over the lap/shoulder belt **4A**. Close the bottom section of the lock-off door cover over the belt. Make sure you push the bottom of the lock-off door all the way down until you hear an audible click **4A**.

**Note:** After the lock-off door is closed, the Tightness Indicator window will turn from **RED** to **GREEN** **4B**. If it does not, unbuckle and return to step 3.

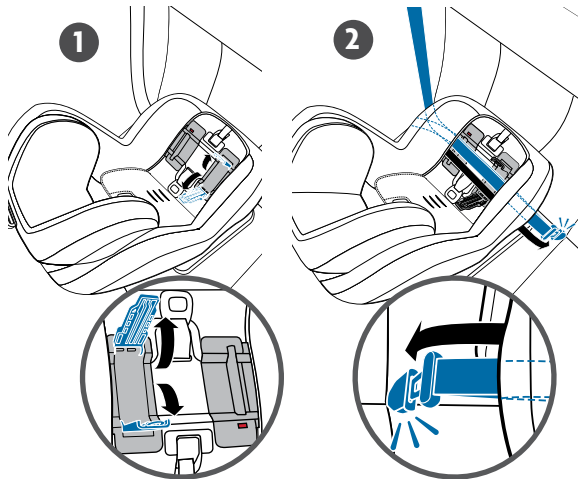



## Rear-Facing Installation – Lap/Shoulder Belt Use

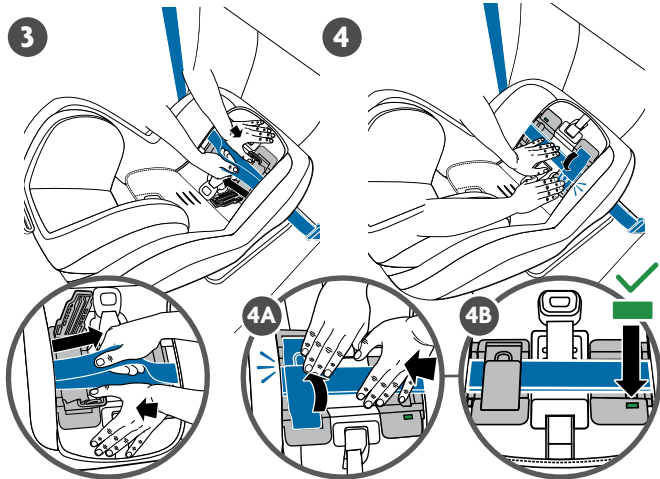

- 5 Using non-dominant hand, check the belt path to ensure no more than 1" (2.5 cm) movement side-to-side and front-to-back.

Proceed to page 54 for  
Multi-Directional Tether usage.



## Rear-Facing Installation – Lap Belt Only Use

- 1 Open the lock-off door.
  - 2 Route the vehicle lap belt through the lock-off and through the **REAR-FACING BLUE** belt path. Ensure there is no twisting. Buckle.
  - 3 Apply pressure into seating surface, as shown, and pull up on excess belt webbing to remove slack from the lap belt.
  - 4 Close the top section of the lock-off door over lap belt **4A**. Close the bottom section of the lock-off door over the belt. Make sure you push the bottom of the lock-off door all the way down until you hear an audible click.
- Note:** After the lock-off door is closed, the Tightness Indicator window will turn from **RED** to **GREEN** **4B**. If it does not, unbuckle and return to step 3.

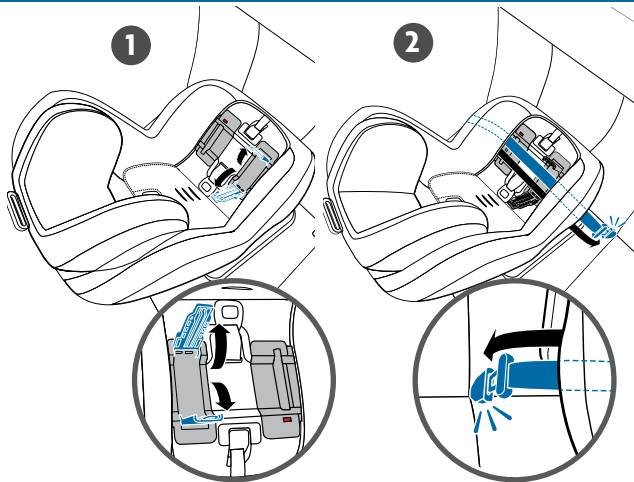

## Rear-Facing Installation – Lap Belt Only Use

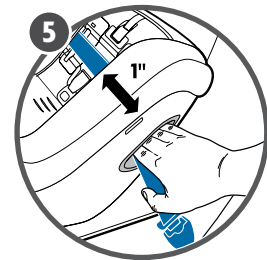
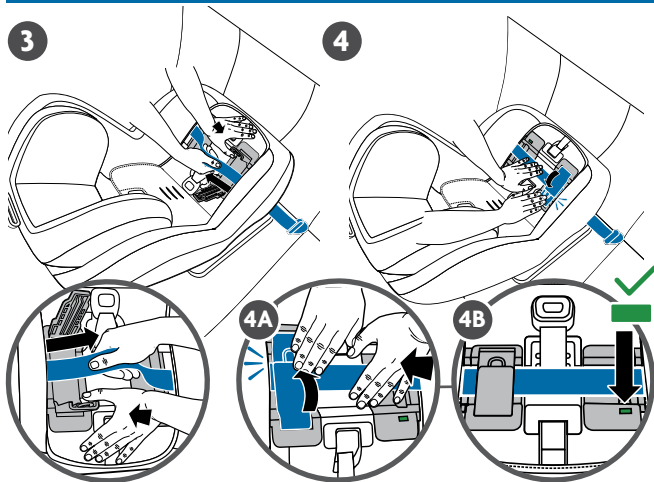

- 5 Using non-dominant hand, check the belt path to ensure no more than 1" (2.5 cm) movement side-to-side and front-to-back.

Proceed to page 54 for  
Multi-Directional Tether usage.



## Rear-Facing Installation – LATCH Setup

**ATTENTION:** This Child Restraint cannot be installed using lower anchors (LATCH) for **REAR-FACING** installation when your child exceeds 40 lbs (18.1 kg). If your child weights over 40 lbs (18.1kg) the vehicle belt **MUST** be used for installation. Installation with LATCH and vehicle seat belt are not permitted together.

**To Access Lower Anchor Connectors** (Illustrations are on the following pages)

- 1 Unsnap the front section of fabric, open the plastic compartment and remove the Lower Anchor Connectors.
- 2 Unzip panel on the cushion of the seat to expose the **REAR-FACING BLUE** Belt Path.
- 3 Make sure the Lower Anchor Connector Belt is not twisted. Route the belt under the fabric and along the plastic indent at front of the seat.

Borrowing of lower anchors in the rear center seating position must be approved by the vehicle manufacturer and may be up to 22" (55.9 cm). If spacing is greater than 22" (55.9 cm) or if the seating position is not approved by the vehicle manufacturer, then use the vehicle seat belt for installation. See page 12 for approved seat configurations

## Rear-Facing Installation – LATCH Setup

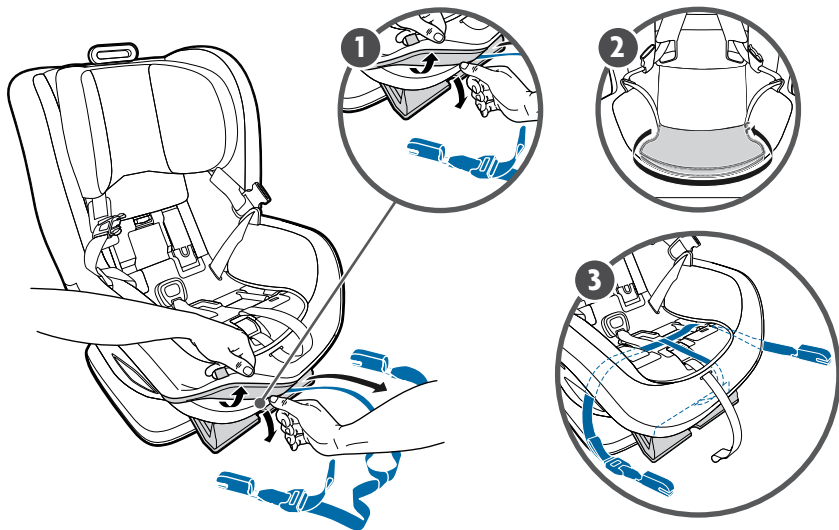



## Rear-Facing Installation – LATCH Use

- 1 Unsnap the front section of fabric and slide Lower Anchor Connectors under the fabric. Unzip fabric panel on the seat. Remove and feed through the **BLUE REAR-FACING** Belt Path. Close lower anchor connector storage compartment and snap fabric. (LATCH set up can be found on page 50.)
- 2 Pull on the ring pull to open the lock-off door **2A**. Route the belt through the lock-off and through the **BLUE REAR-FACING** belt path.
- 3 Push lower anchor connectors onto the lower anchors located in your vehicle seat bight (where your cushion and back meet). There should be an audible 'click' when attachment takes place. (3-4 illustrations on next page)

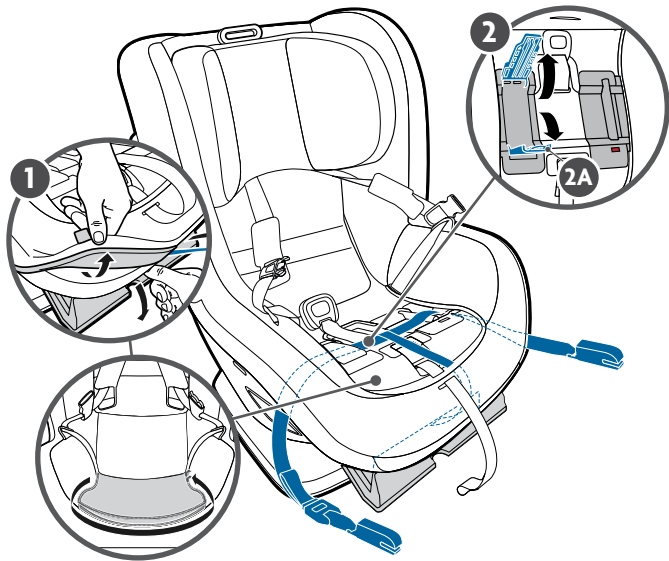

## Rear-Facing Installation – LATCH Use

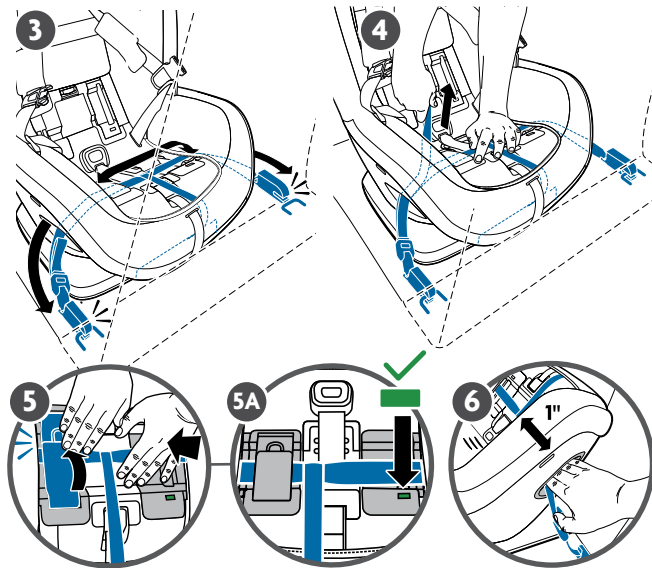

- 4 Apply pressure into seating surface, as shown, and pull up on the excess lower anchor connector webbing to remove any slack.
- 5 Close the top section of the lock-off door over the lap/shoulder belt. Second, close the bottom section of the lock-off door over the belt. Make sure you push the bottom of the lock-off door all the way down until you hear an audible click.  
**Note:** After the lock-off door is closed, the Tightness Indicator window will turn from **RED** to **GREEN**.  
**5A** If it does not, disconnect and return to step 2.
- 6 Using non-dominant hand, check the belt path to ensure no more than 1" (2.5 cm) movement side-to-side and front-to-back.

Proceed to page 54 for  
Multi-Directional Tether usage.

## Rear-Facing Installation – Rear-Facing Tether Use

**ATTENTION: IT IS STRONGLY RECOMMENDED** to utilize the Multi-Directional Tether for **REAR-FACING** installation if vehicle is equipped with a Tether Anchor point and vehicle requirements are met. The tether will improve the stability of your Child Restraint and reduce the risk of injury. See your vehicle owner's manual for approved anchor locations.

- 1 Route the Multi-Directional Tether through the guide located on the back of the seat as shown.
- 2 Route the webbing either through the vehicle headrest posts or if an integrated headrest exists to the inboard side of the headrest (for rear-facing) (2-5 illustrations on next page)
- 3 Hook the Multi-Directional Tether to an approved vehicle Tether (LATCH) location. Please refer to your vehicle owner's manual. (Illustration on next page)
- 4 Pull up on the strap as shown until the webbing is taut. (Illustration on next page)
- 5 Excess webbing **MUST** be rolled around the fabric sleeve and secured with closure provided. (Illustration on next page)

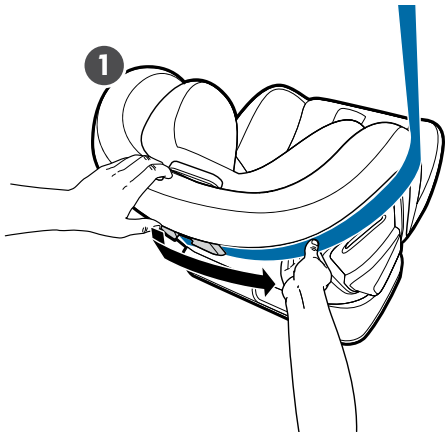



## Rear-Facing Installation – Rear-Facing Tether Use

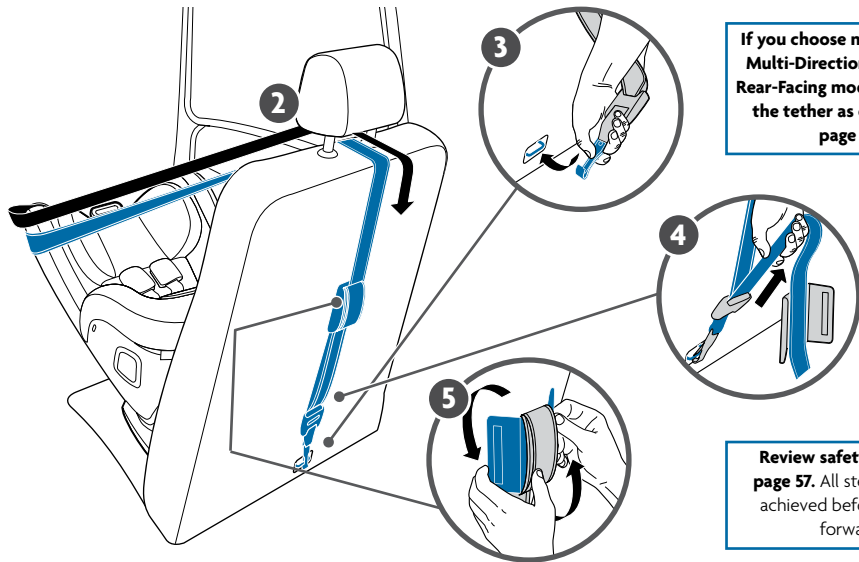

If you choose not to use the Multi-Directional Tether in Rear-Facing mode, then store the tether as outlined on page 36.

Review safety check on page 57. All steps must be achieved before moving forward.



## Rear-Facing Installation – Aircraft Use



**Certified for Aircraft Travel:** This child seat is certified for aircraft use. The FAA recommends that a child weighing up to 40 lbs (18.1 kg) use a certified, harnessed child seat while traveling on an aircraft. Contact the airline about their policy prior to traveling.

### For Rear-facing Aircraft Installation



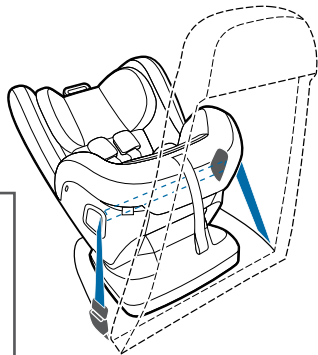

- 1 Recline this child seat and place **REAR-FACING** on the aircraft seat.
- 2 Route the aircraft lap belt through the **REAR-FACING BLUE** belt path and over closed lock-off door. Ensure there is no twisting. Buckle.
- 3 Remove all slack to secure child seat in airline seat.

### Safety Reminders and Tips

- This seat may not fit all aircrafts. Contact your airline prior to travel to verify fit.
- Install your child seat in a window seat to avoid blocking the aisle.
- If the aircraft lap belt is too short, ask a flight attendant for a belt extender.
- Inflatable aircraft lap belts are not compatible with this child seat.



## Rear-Facing Installation – Safety Check

    Tightness Indicator window is **GREEN**.

Occasionally check Child Restraint for tightness in the belt path and lift the fabric panel to ensure Tightness Indicator remains **GREEN**. It is possible to achieve a tight installation even if the indicator is not fully green. Always check belt path for no more than 1" (2.5 cm) movement.

---

**Check at the Belt Path** to ensure there is not more than 1" (2.5 cm) of movement side to side or front to back. If there is more than 1" (2.5 cm) of movement, repeat installation steps.

---

For lap belt only and lap/shoulder belt installation, make sure the belt is routed through the lock-off and fully secured under the lock-off door when closed.

---



**ALWAYS** check the Recline Position Indicator. The bubble should be between the correct **BLUE** area for **REAR-FACING INSTALLATION**.



## Forward-Facing Installation

30–65 lbs (13.6–29.5 kg)





**Vehicle belt: 30–65 lbs** (page 62)



**LATCH: 30–45 lbs** (page 64)

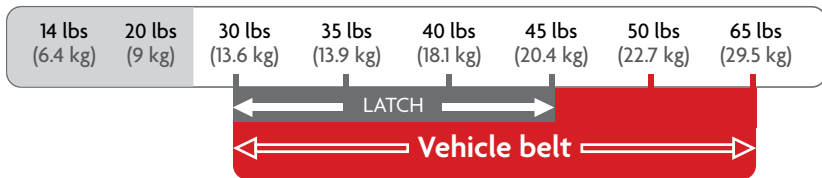

## Forward-Facing Installation – Setup

- 1 Place Child Restraint on vehicle seat in **FORWARD-FACING** direction as shown. Ensure the bottom surface is in full contact with the vehicle seating surface.
- 2 Confirm for **FORWARD-FACING** that the seat is reclined so the indicator sits in the red zone.
- 3 Slide Child Restraint towards back of vehicle seat until contact is made with vehicle seat back.
- 4 Loosen harness by pressing the Harness Release Button and pulling harness forward. Unbuckle harness.
- 5 Raise headrest by squeezing the Headrest

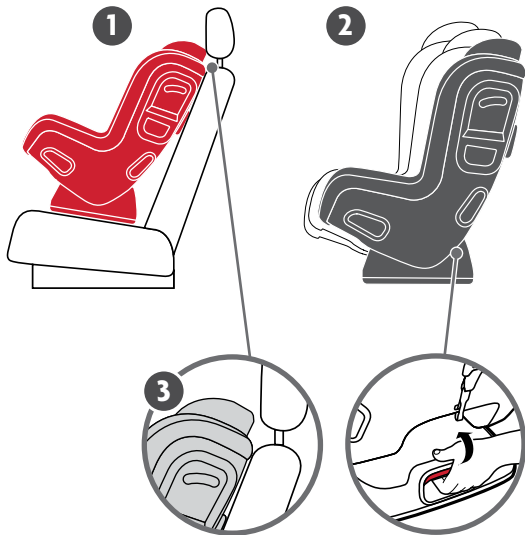

**Note:** 80% of the base should be in contact with the vehicle cushion.



## Forward-Facing Installation – Setup

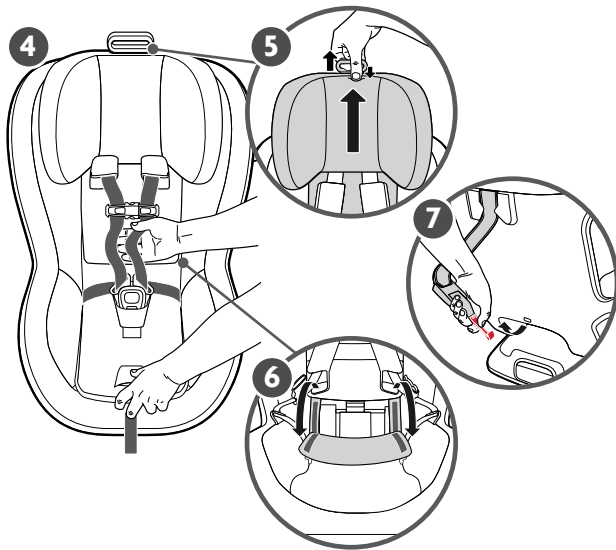

Adjuster by pushing down and pulling up on handle as shown then pull upward to allow access to the **RED FORWARD-FACING** belt path.

- 6 Unfasten the fabric panel and pull forward.
- 7 Remove Multi-Directional Tether from storage, lengthen webbing and place on front side of the seat prior to installation (page 70).

To complete **FORWARD-FACING** installation, please refer to:  
**Lap/shoulder Belt** page 62  
**Lap Belt Only** page 64  
**Latch** page 66



## Forward-Facing Installation – Lap/Shoulder Belt Use

Place Multi-Directional Tether on front side of the seat prior to installation.

- 1 Open lock-off door.
- 2 Ensuring there is no twisting in the belt, route vehicle lap/shoulder through the lock-off door and through the **RED FORWARD-FACING** belt path. Buckle.
- 3 While applying pressure into seating surface, as shown, pull up on the vehicle shoulder belt to tighten the belt. Holding the shoulder belt taut to ensure no slack is introduced back into the vehicle belt, route over the lock-off door
- 4 Close the bottom section of the lock-off door over the lap/shoulder belt. Close the top section of the lock-off door over the belt. Make sure you push the bottom of the lock-off door all the way down until you hear an audible click **4A**.

**Note:** After closing the lock-off door, the Tightness Indicator window will turn from **RED TO GREEN 4B**. If it does not, unbuckle and return to step 2.

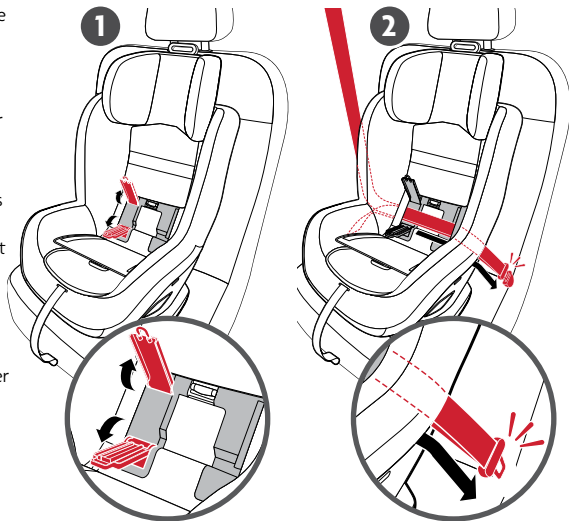



## Forward-Facing Installation – Lap/Shoulder Belt Use

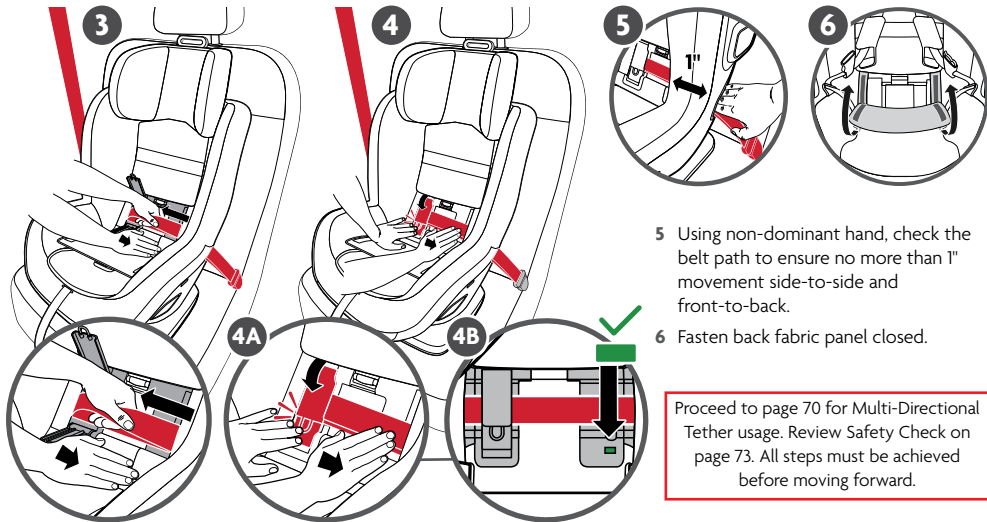

- 5 Using non-dominant hand, check the belt path to ensure no more than 1" movement side-to-side and front-to-back.
- 6 Fasten back fabric panel closed.

Proceed to page 70 for Multi-Directional Tether usage. Review Safety Check on page 73. All steps must be achieved before moving forward.



## Forward-Facing Installation – Lap Belt Only Use

- 1 Open lock-off door.
- 2 Ensuring there is no twisting in the vehicle belt, route the lap belt through the lock-off door and along the **RED FORWARD-FACING** path. Buckle.
- 3 Apply pressure into seating surface, as shown, and pull up on excess belt webbing to remove slack from the lap belt. (steps 3-4 illustrations on next page)
- 4 Close the bottom section of the lock-off door over the lap/shoulder belt. Close the top section of the lock-off door over the belt. Make sure you push the bottom of the lock-off door all the way down until you hear an audible click **4A**.  
**Note:** After closing the lock-off door, the Tightness Indicator window will turn from **RED TO GREEN 4B**. If it does not, unbuckle and return to step 2.

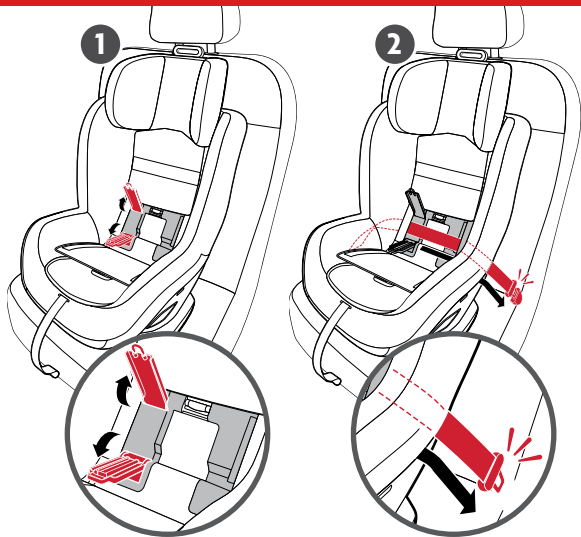

## Forward-Facing Installation – Lap Belt Only Use

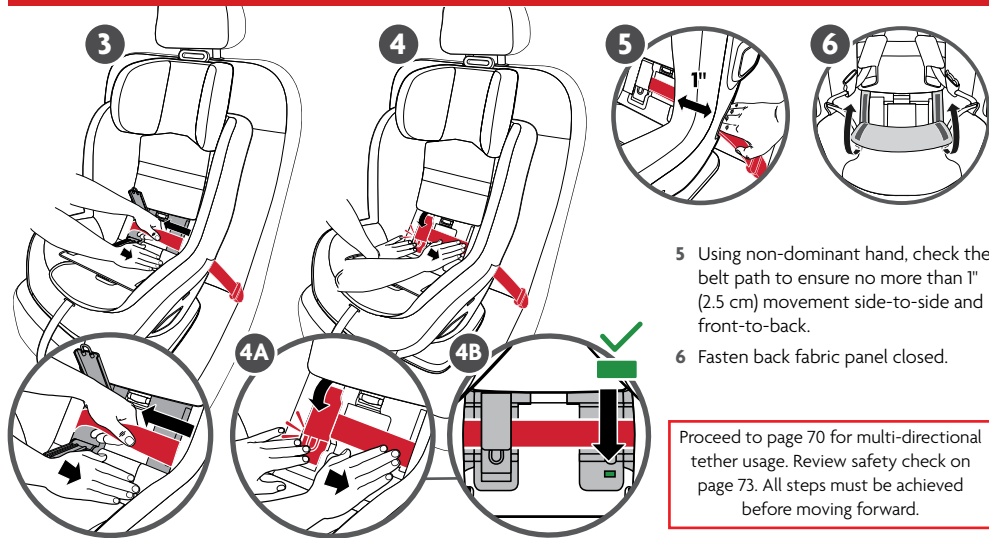

5 Using non-dominant hand, check the belt path to ensure no more than 1" (2.5 cm) movement side-to-side and front-to-back.

6 Fasten back fabric panel closed.

Proceed to page 70 for multi-directional tether usage. Review safety check on page 73. All steps must be achieved before moving forward.



## Forward-Facing Installation – LATCH Setup

**ATTENTION:** This Child Restraint cannot be installed using lower anchors LATCH) for **FORWARD-FACING** installation when your child exceeds 45 lbs (20.4 kg). If your child weighs over 45 lbs (20.4 kg) the vehicle belt must be used for installation.

### To Access Lower Anchor Connectors

(Steps 1-4 - illustrations on next page)

- 1 To access Lower Anchor Connectors unsnap fabric over front panel of Child Restraint. Open the storage compartment and pull out the Lower Anchor Connectors.
- 2 Lengthen the Lower Anchor Connector to maximize length by pushing the Lower Anchor Connector button downward and pulling to full extension.
- 3 Raise headrest to maximum height by pushing down and pulling up on handle.
- 4 Unfasten back fabric panel to expose **RED FORWARD-FACING** Belt Path. Guide Lower Anchor Connectors under fabric opening and pull through.

## Forward-Facing Installation – LATCH Setup

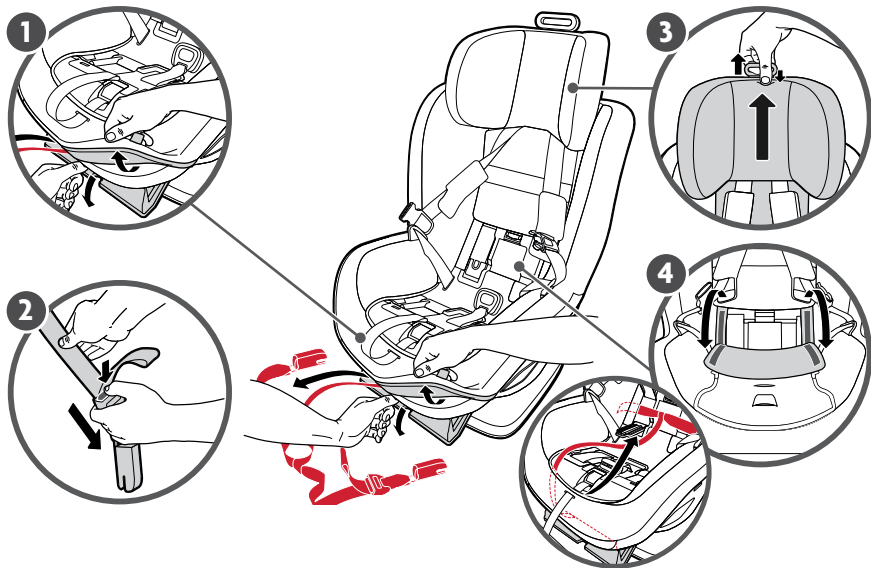



## Forward-Facing Installation – LATCH Use

**ATTENTION:** This Child Restraint cannot be installed using lower anchors (LATCH) for **FORWARD-FACING** installation when your child exceeds 45 lbs (20.4 kg). If your child weighs over 45 lbs (20.4 kg) the vehicle belt must be used for installation.

**Note:** To get more length in the Lower Anchor Connector Webbing, press the adjuster and pull the belt.

- 1 Open lock-off door **1A**.
- 2 Ensuring the Lower Anchor Connector Belt is not twisted, route the belt across the lock-off and through the respective left and right **RED FORWARD-FACING** Belt Paths. (LATCH set up can be found on page 66.)
- 3 Attach to Lower Anchors (LATCH) in vehicle. Listen for an audible click. (Steps 3-4 illustrations on next page)
- 4 Apply pressure into back seating surface, as shown, and pull up on the excess lower anchor connector belt to remove any slack.

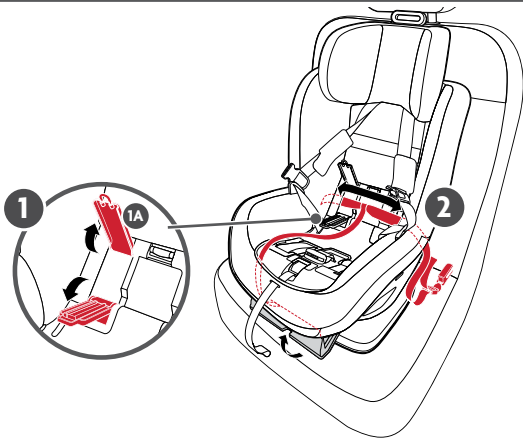

## Forward-Facing Installation – LATCH Use

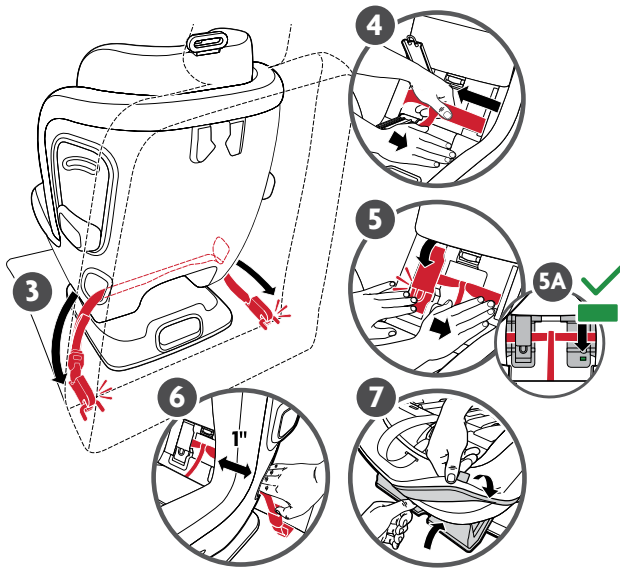

- 5 Close the bottom section of the lock-off door over the lap/shoulder belt. Second, close the top section of the lock-off door over the belt. Make sure you push the bottom of the lock-off door all the way down until you hear an audible click .

**Note:** As pressure is applied, the Tightness Indicator window will turn from **RED** to **GREEN** 5A.

- 6 Using non-dominant hand, check the belt path to ensure no more than 1" movement side-to-side and front-to-back. It is possible to achieve a tight installation even if the indicator is not fully green.
- 7 Close the Lower Anchor Connector Storage Compartment, snap fabric over door and fasten the fabric panel along the back.

## Forward-Facing Installation – Forward-Facing Tether Use

**ATTENTION: IT IS STRONGLY RECOMMENDED** to utilize the multi-directional tether for **FORWARD-FACING** installation if vehicle is equipped with a tether anchor point and vehicle requirements are met. The tether will improve the stability of your child restraint and reduce the risk of injury. See your vehicle owner's manual for approved anchor locations.

- 1 Route the webbing either through the vehicle headrest posts or, if an integrated headrest exists, over the top of the headrest.
- 2 Hook the Multi-Directional Tether to an approved vehicle Tether (LATCH) location. Please refer to your vehicle owner's manual.

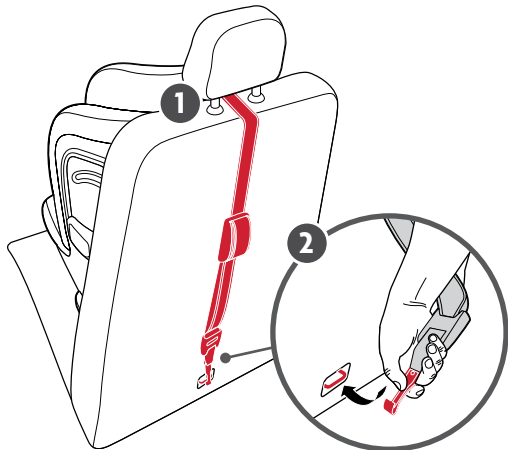

**Review Safety Check on page 73.**

All steps must be achieved before moving forward.



## Forward-Facing Installation – Forward-Facing Tether Use

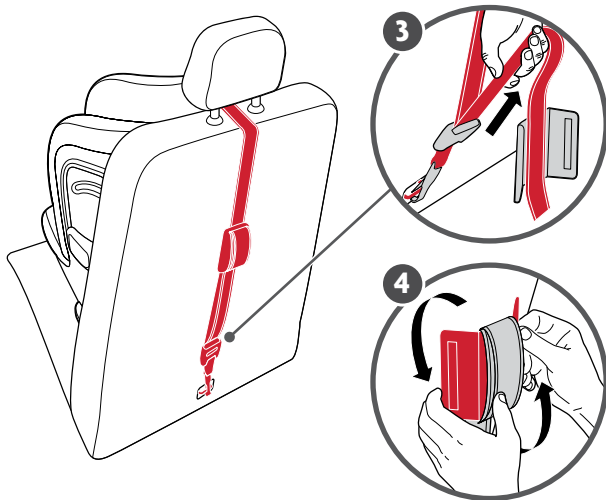

- 3 Pull up on the strap as shown until webbing is taut.
- 4 Excess webbing **MUST** be rolled around the fabric sleeve and secured with closure provided. Route the webbing either through the vehicle headrest posts or, if an integrated headrest exists, over the top of the headrest.

## Forward-Facing Installation – Aircraft Use



**Certified for Aircraft Travel:** This child seat is certified for aircraft use. The FAA recommends that a child weighing up to 45 lbs (20.4 kg) use a certified, harnessed child seat while traveling on an aircraft. Contact the airline about their policy prior to traveling.

### For forward-facing aircraft installation:



- 1 Place this child seat **FORWARD-FACING** on the aircraft seat in the upright position.
- 2 Route the aircraft lap belt through the **FORWARD-FACING RED** belt path and over closed lock-off door. Ensure there is no twisting. Buckle.
- 3 Remove all slack to secure child seat in airline seat.

### Safety Reminders and Tips

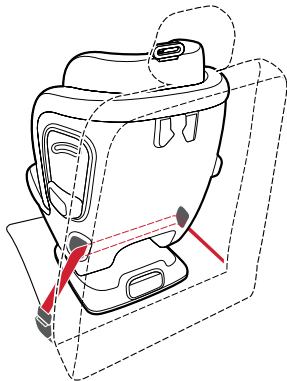
- This seat may not fit all aircrafts. Contact your airline prior to travel to verify fit.
- Install your child seat in a window seat to avoid blocking the aisle.
- If the aircraft lap belt is too short, ask a flight attendant for a belt extender.
- Inflatable aircraft lap belts are not compatible with this child seat.



## Forward-Facing Installation – Safety Check

    Tightness Indicator window is **GREEN**.

Occasionally check Child Restraint for tightness in the belt path and lift the fabric panel to ensure Tightness Indicator remains **GREEN**. It is possible to achieve a tight installation even if the indicator is not fully green. Always check belt path for no more than 1" (2.5 cm) movement.

---

**Check at the Belt Path** to ensure there is not more than 1" (2.5 cm) of movement side to side or front to back. If there is more than 1" (2.5 cm) of movement, repeat installation steps.

---

For lap belt only and lap/shoulder belt installation, make sure the belt is routed through the lock-off and fully secured under the lock-off door when closed.

---



**ALWAYS** check the Recline Position Indicator. The bubble should be between the correct area for **FORWARD-FACING**.

## Fabric Care – Removing Seat Pad

- 1 Raise headrest to highest position.
- 2 Unfasten back panel fabric. Fully unzip seat cushion fabric.
- 3 Remove crotch buckle cover.
- 4 Release seat cushion fabric.

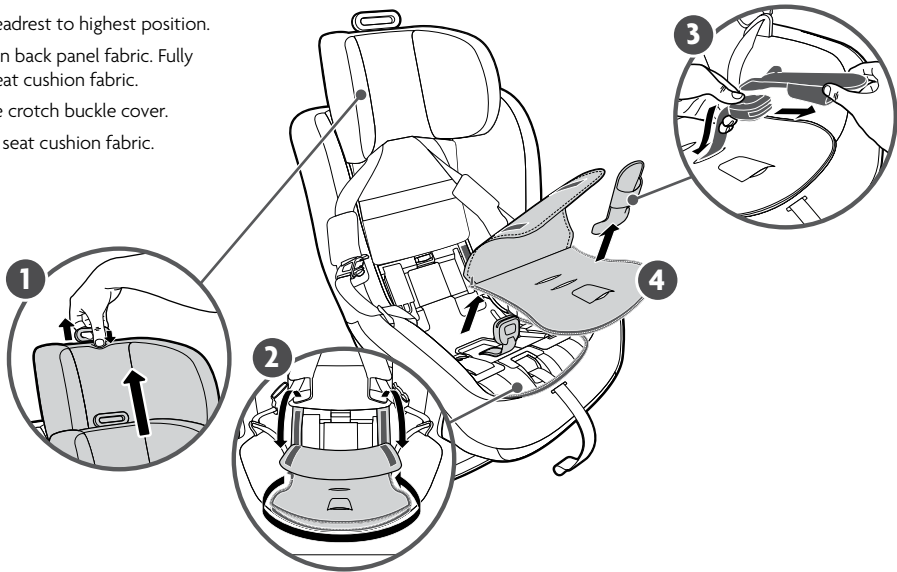

## Fabric Care – Removing Headrest Fabric

- 1 Raise headrest to highest position.

**Note:** If headrest will not raise, the internal harness may need to be loosened.

- 2 Unfasten headrest fabric from structure

- 3 Unhook pocket from lower portion of headrest.

- 4 Pull headrest fabric upward from spine structure and remove from seat.

**Note:** DO NOT remove foam from seat. It cannot be cleaned.

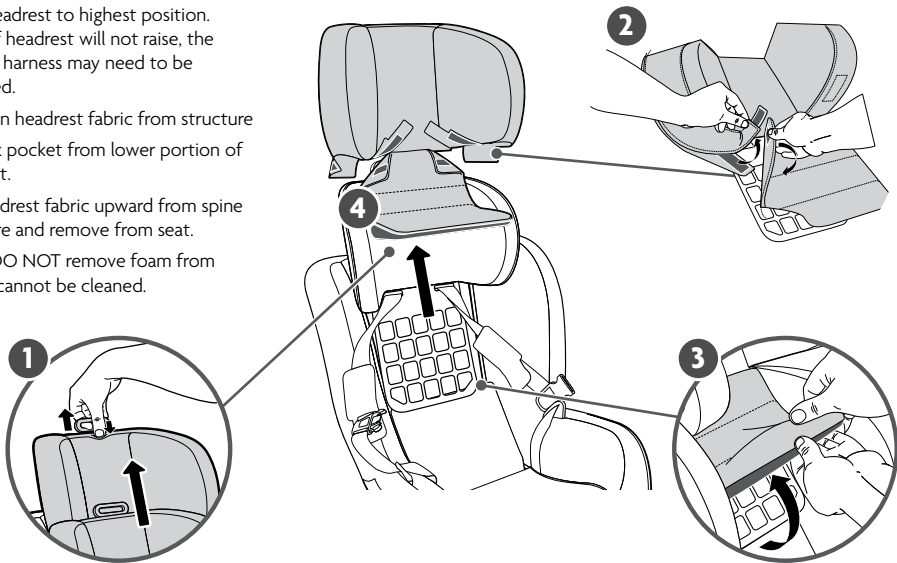

## Fabric Care – Removing Seat Fabric

- 1 Pull seat fabric up around top of seat to loosen.
- 2 Pull body fabric from channel along side of seat.
- 3 Unsnap seat base fabric.  
(Steps 3-5 illustrations on next page)
- 4 Feed harness adjustment strap through hole of bottom of seat fabric.
- 5 Pull fabric out from around Harness Adjuster Housing and remove from seat.

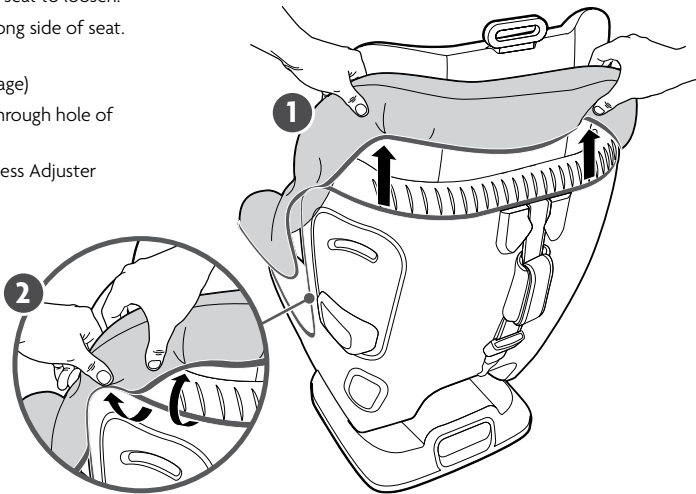

## Fabric Care – Removing Seat Fabric

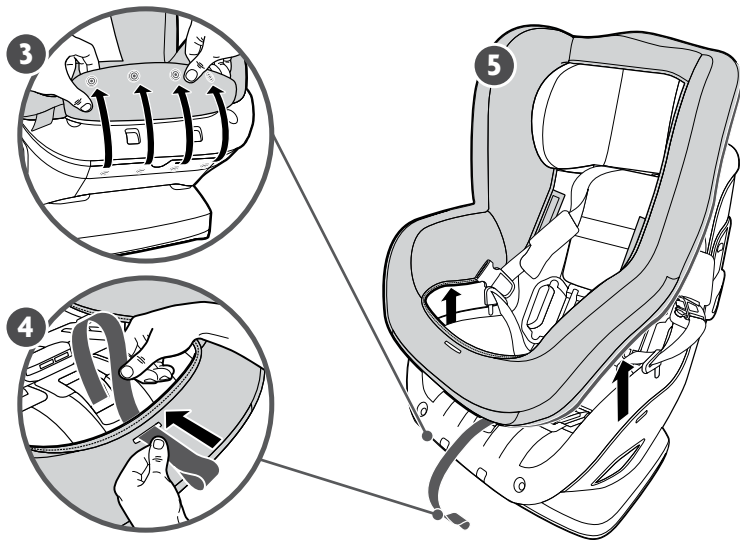

## Fabric Care – Installing Seat Fabric

- 1 Place seat fabric over seat.
- 2 Moving from the top down, press fabric into channel along side of seat.
- 3 Snap seat base fabric.
- 4 Pull fabric out and remove from around the seat.

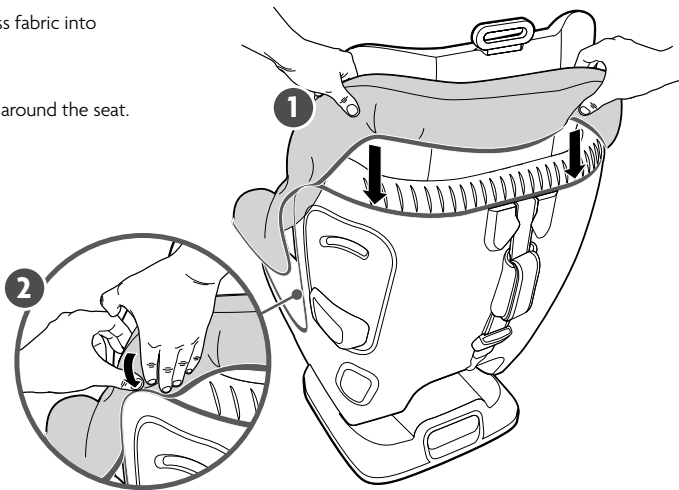



## Fabric Care – Installing Seat Fabric

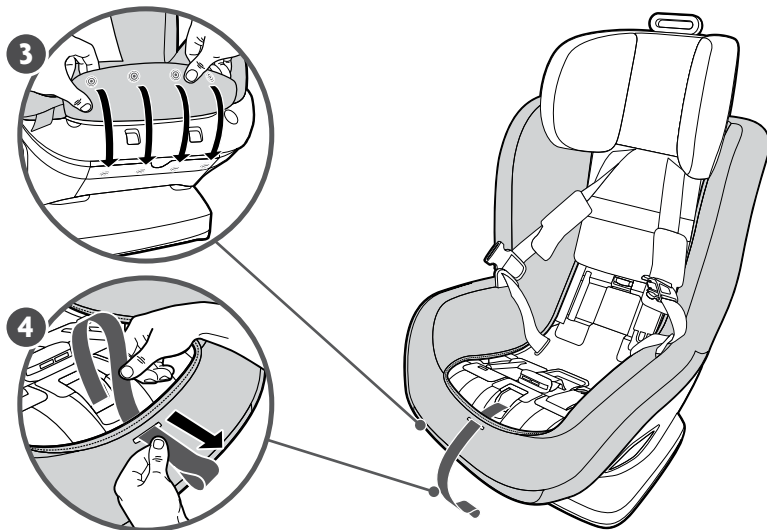

## Fabric Care – Installing Headrest Fabric

- 1 Raise headrest to highest position.  
**Note:** If headrest will not raise, the internal harness may need to be loosened.
- 2 Pull headrest fabric over spine structure and secure onto seat.
- 3 Place fabric over lower portion of headrest.
- 4 Fasten headrest to seat.

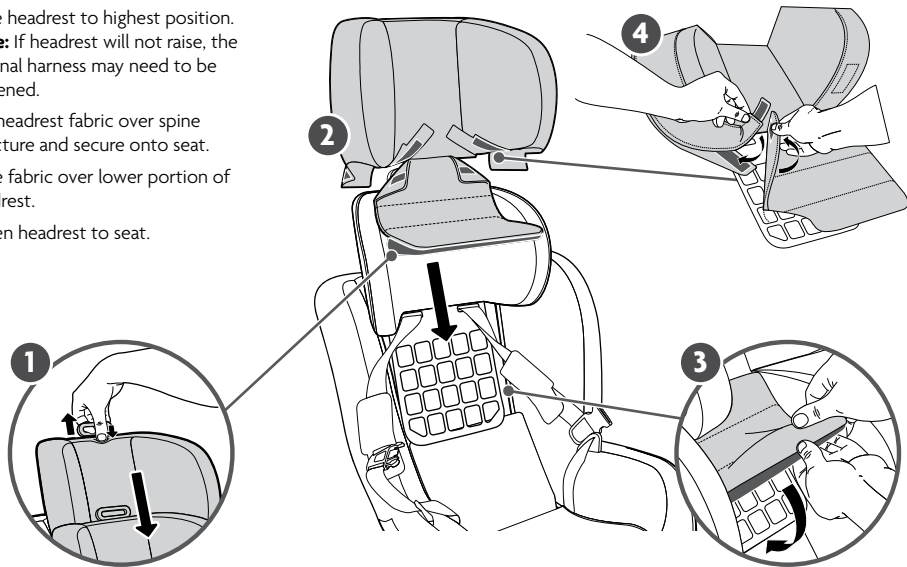

## Fabric Care – Installing Seat Pad

- 1 Raise headrest to highest position.
- 2 Slip buckle through slit in bottom fabric panel. Attach crotch buckle cover.
- 3 Fully zip seat base fabric and fasten back panel fabric.

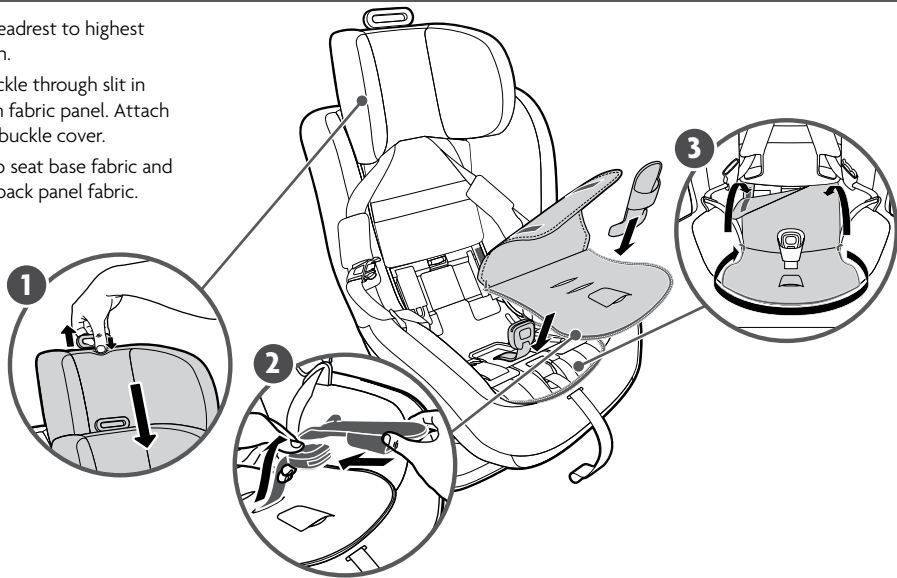

## Cleaning and Maintenance

**CLEANING FABRICS** — Fabrics include: seat and headrest covers, harness covers, comfort inlay and crotch buckle cover.



Machine wash in warm water on gentle cycle with mild detergent. **DO NOT** bleach.



Secure all hook and loop fasteners before laundering.



Tumble Dry Low.



**DO NOT** iron or dry clean.

### CLEANING HARNESS WEBBING



Spot clean using warm water with mild detergent. **DO NOT** bleach.



Air dry completely before re-use or storage.

### CLEANING PLASTIC



Spot clean using warm water with mild detergent.



Towel dry completely before re-use or storage.

**Cleaning Lower Anchor Connectors** — Anchors should fasten with a “click”. If not, rinse under warm running water. **DO NOT** use detergents or lubricants.

## Warranty

### PRODUCT LIFETIME WARRANTY

Lifetime warranty applies to UPPAbaby car seats and only the original owner, within the lifetime of the product. To receive your Limited Lifetime Warranty, you **MUST** register your car seat within three months of purchase and provide a valid purchase receipt from an authorized UPPAbaby retailer. The “lifetime” of the product is defined as the period of use by the registrant for use with his/her children up to 7 years from date of manufacture. Register your product at: [uppababy.com/register/carseat](http://uppababy.com/register/carseat)

Your UPPAbaby product is warranted to be free from manufacturing defects for a period of 2 years from the date of purchase under normal use and in compliance with the operating instructions.

This warranty is not transferable and extends only to the original retail purchaser and is only valid when supplied with proof of purchase from an authorized retailer. Proof of purchase must be retained for this warranty.

The warranty is valid only in the original country of purchase. This warranty is subject to the conditions set forth by country in which the items were purchased. Conditions may vary. UPPAbaby will not ship replacement or repair parts outside the country of purchase.

UPPAbaby will provide replacement parts or conduct repairs as determined fitting by the company. UPPAbaby reserves the right to exchange item with a replacement part. Some parts may be replaced with newer model parts as the item is improved over time.

## Warranty

This warranty does not cover:

- Defects caused by misuse or poor maintenance. (Please refer to the product instruction booklet for guidance on item use and maintenance).
- Damage caused by improper installation of UPPAbaby parts and/or accessories. (Please refer to product instruction booklet for guidance on item assembly and use).
- Damage caused by corrosion, mold or rust due to poor maintenance, service or storage.
- Damage resulting from normal wear and tear.
- Damage or degradation caused by the sun, sweat, detergents, damp storage conditions or frequent washings.
- Repairs or modifications carried out by a third party.
- Product purchased from an unauthorized retailer. (Approved retailers are listed on our website [uppababy.com](http://uppababy.com)).
- Second owners and users other than the registrant.
- Damage resulting from airline shipping and handling.
- Products Involved in an accident.

UPPAbaby reserves the right to determine if warranty terms and conditions have been met.

For warranty service: In the US and CA please contact UPPAbaby customer service (844) 823-3132 and visit [uppababy.com/support](http://uppababy.com/support) to send an email.





USA | UPPAbaby, 276 Weymouth Street, Rockland, MA 02370

[uppababy.com](http://uppababy.com) | 1.844.823.3132

Model 1103-ROV-US

All rights reserved. © 2024 UPPAbaby. UPPAbaby and all associated logos are trademarks. All product specifications are correct at time of print. UPPAbaby reserves the right to change anything at any time without prior notice. Color representation is as close as print processes allow. Not all colors available at all retailers. UbMAN182-V05